

Persiana Smart 90

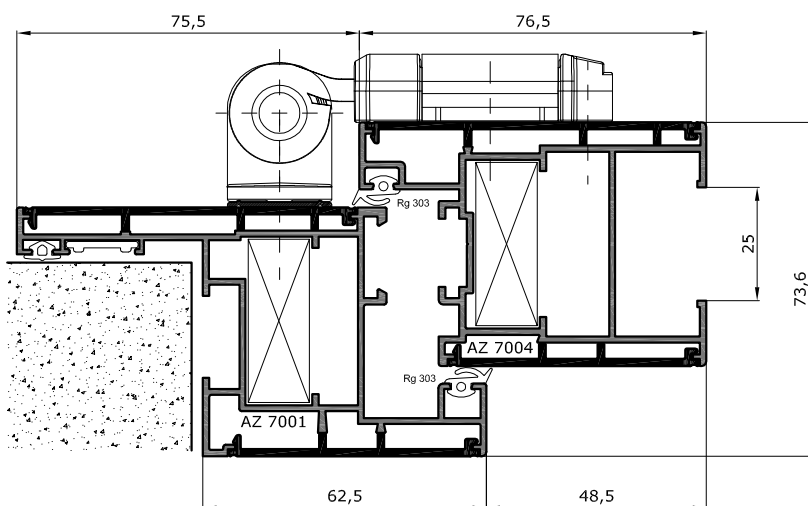

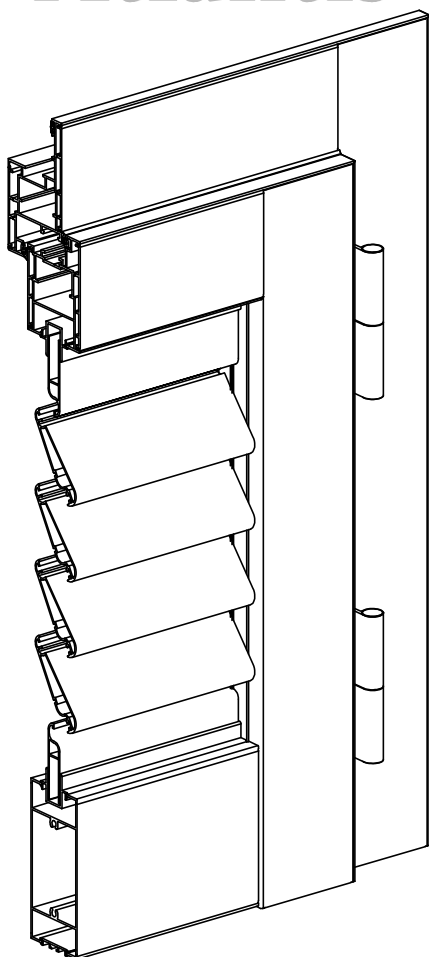

Atlantis





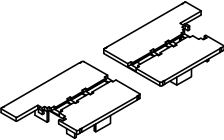
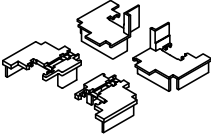
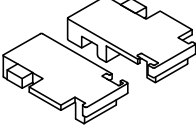
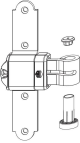
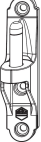

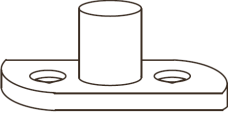
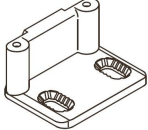
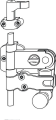
ACCESSORI accessories
GUARNIZIONI weatherstrips

Persiana Smart 90



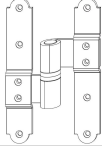

Accessori e guarnizioni

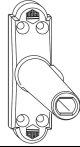
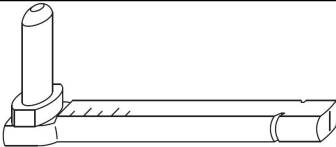
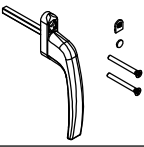
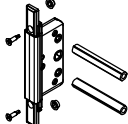
SIGLA	PROFILO	DESCRIZIONE
Ra 4500		COPPIA TAPPI SOTTO MONTANTE ANTA
Ra 4501		DOPPIA COPPIA TAPPI RIPORTO CON E SENZA SPAZZOLINO
Ra 4502		COPPIA TAPPI COMPENSATORE
Ra 4503		BANDELLA CROCE RUSTICO IN ACCIAIO GO=2 CR= 16-24 NERO
Ra 4504		CARDINE SU PIASTRA RUSTICO IN ACCIAIO SC 19,5 NERO OPACO
Ra 4505		SPESSORE 1MM NERO IN ACCIAIO ACCATASTABILE PER CARDINE SU PIASTRA (202224)
Ra 4506		PIASTRA AI CHIUSURA R7 40X14 CON PERNO H=20MM NERO OPACO
Ra 4507		PIASTRA AI CHIUSURA AD ANGOLO M2 PERNI D=8MM SENZA TASSELLI E VITI NERO OPACO
Ra 4508		SPAGNOLETTA 2 ANTE MANIGLIA STANDARD SENZA PIASTRA DI CHIUSURA CON GRIFFE AUTOREGOLANTE H=15MM NERO OPACO
Ra 4509		MANIGLIA A SCATTO SENZA PIASTRA AI CHIUSURA CON GRIFFE AUTOREGOLANTE H=15MM NERO OPACO

Accessori e guarnizioni

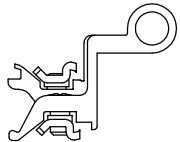
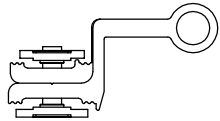
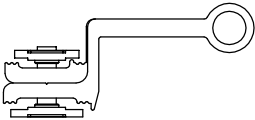
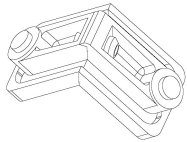
SIGLA	PROFILO	DESCRIZIONE
Ra 4510		ASTA SPAGNOLETTA 1400mm NERO OPACO
Ra 4511		ASTA SPAGNOLETTA 1600mm NERO OPACO
Ra 4512		ASTA SPAGNOLETTA 2200mm NERO OPACO
Ra 4513		ASTA SPAGNOLETTA 2400mm NERO OPACO
Ra 4514		ASTA SPAGNOLETTA 2600mm NERO OPACO
Ra 4515		ASTA SPAGNOLETTA 3200mm NERO OPACO
Ra 4516		CERNIERA CENTRALE A CROCE RUSTICO IN ACCIAIO 40-40 DP25 DESTRO NERO OPACO
Ra 4517		CERNIERA CENTRALE A CROCE RUSTICO IN ACCIAIO 40-40 DP25 SINISTRO NERO OPACO
Ra 4518		BANDELLA CROCE RUSTICO IN ACCIAIO GO= 32-55 CR= 16-24 SENZA ANGOLO D'APPOGGIO REG. LAT. NERO OPACO
Ra 4519		MENSOLA CON MOLLA AI SICUREZZAQ SP=20MM L=25MM PER CARDINE MONOBLOCCO L85 NERO OPACO
Ra 4520		CARDINE MONOBLOCCO REGOLABILE CON TACCA AI SICUREZZA 15MM MONOBLOCCO CON REGOLAZIONE LATERALE L85 SC30-70 NERO OPACO
Ra 4521		MARTELLINA
Ra 4522		MOVIMENTAZIONE BIDIREZIONALE GHIBO OUT BS 29"

Accessori e guarnizioni







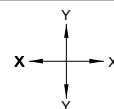
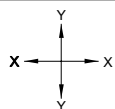

SIGLA	PROFILO	DESCRIZIONE
Ra 4523		Cerniere mono anta
Ra 4524		Cerniere 3° anta
Ra 4525		Cerniere collo alto 3° anta
Ra 1048		Squadretta a tiraggio esterno
Ra 1410		Squadretta di allineamento
Rg 331		Guarnizione di battuta a muro
Rg 303		Guarnizione di battuta

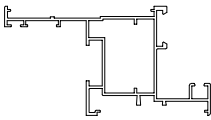
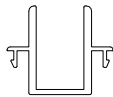
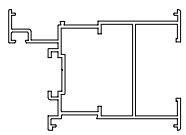
PROFILI
profiles

Persiana Smart 90

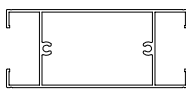
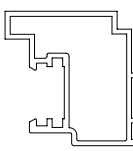
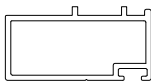
ELENCO PROFILI



PROFILI	SIGLA Jx cm ⁴ Jy cm ⁴	peso g/m	utilizzo	PROFILI	SIGLA Jx cm ⁴ Jy cm ⁴	peso g/m	utilizzo
	AZ 7001 Jx 14,32 Jy 30,65	1181	Telaio a "Z"		T 377	356	Posizionatore da 25 mm Universal
	AZ 7002 Jx 12,73 Jy 21,25	1117	Anta		AZ 2068	153	Portaspazzolino
	AZ 7003	351	Carter da 73				
	AZ 7004	265	Carter da 55				
	AZ 7005 Jx 22,65 Jy 75,10	1635	Fascia da 110 mm				
	AZ 7007 Jx 4,46 Jy 3,28	665	Riscontro centrale				
	AZ 7008	443	Compensatore sotto anta				
	T 3323	526	Lamella Universal con rigo				
	T 3324	526	Lamella Universal senza rigo				
	T 370	392	Mezza Lamella Universal				

scala 1:1

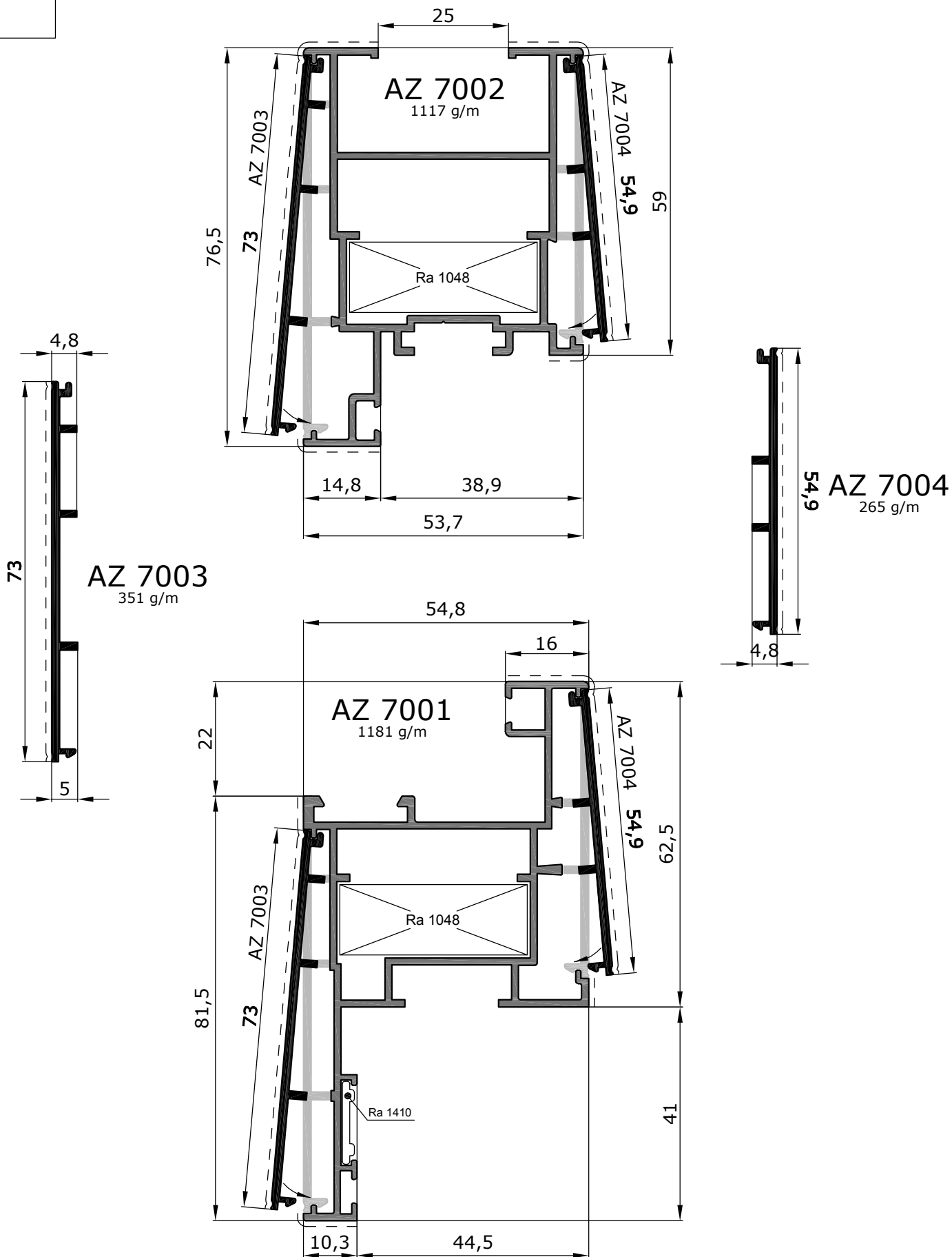

scala 1:1

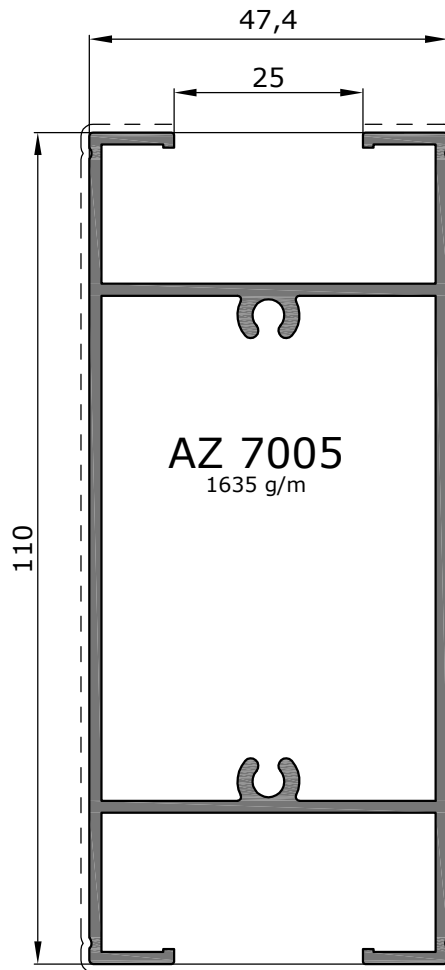
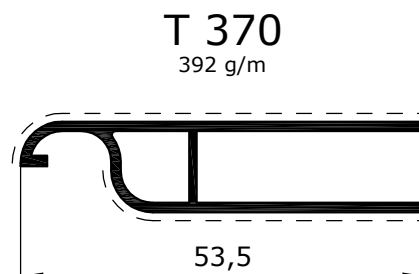
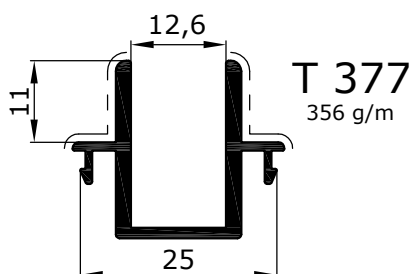
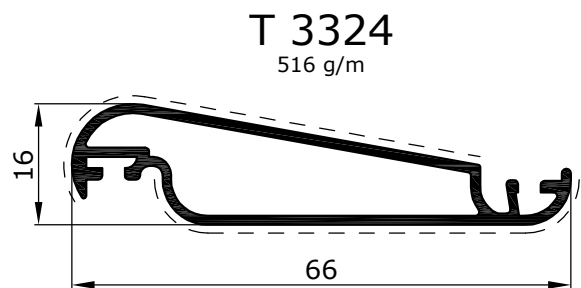
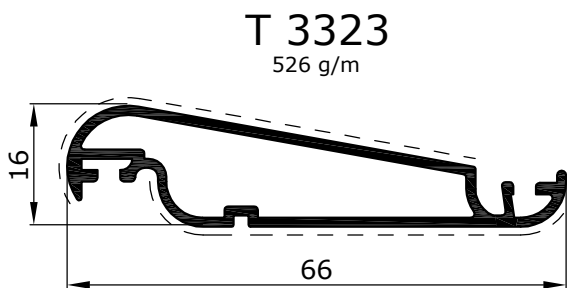
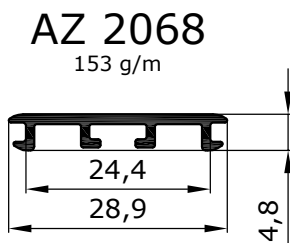
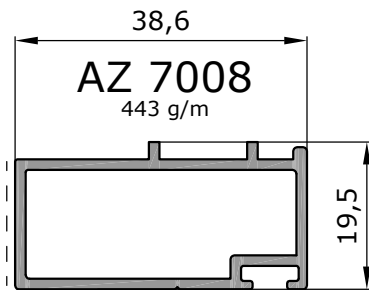
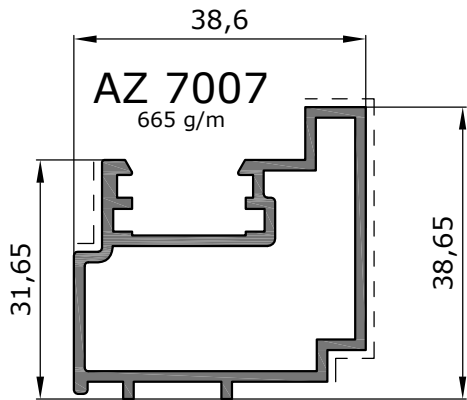

SEZIONI
Sections

Persiana Smart 90

Sezione laterale Persiana 90
 due ante cerniere tipo standard
 o bandella a croce rustico

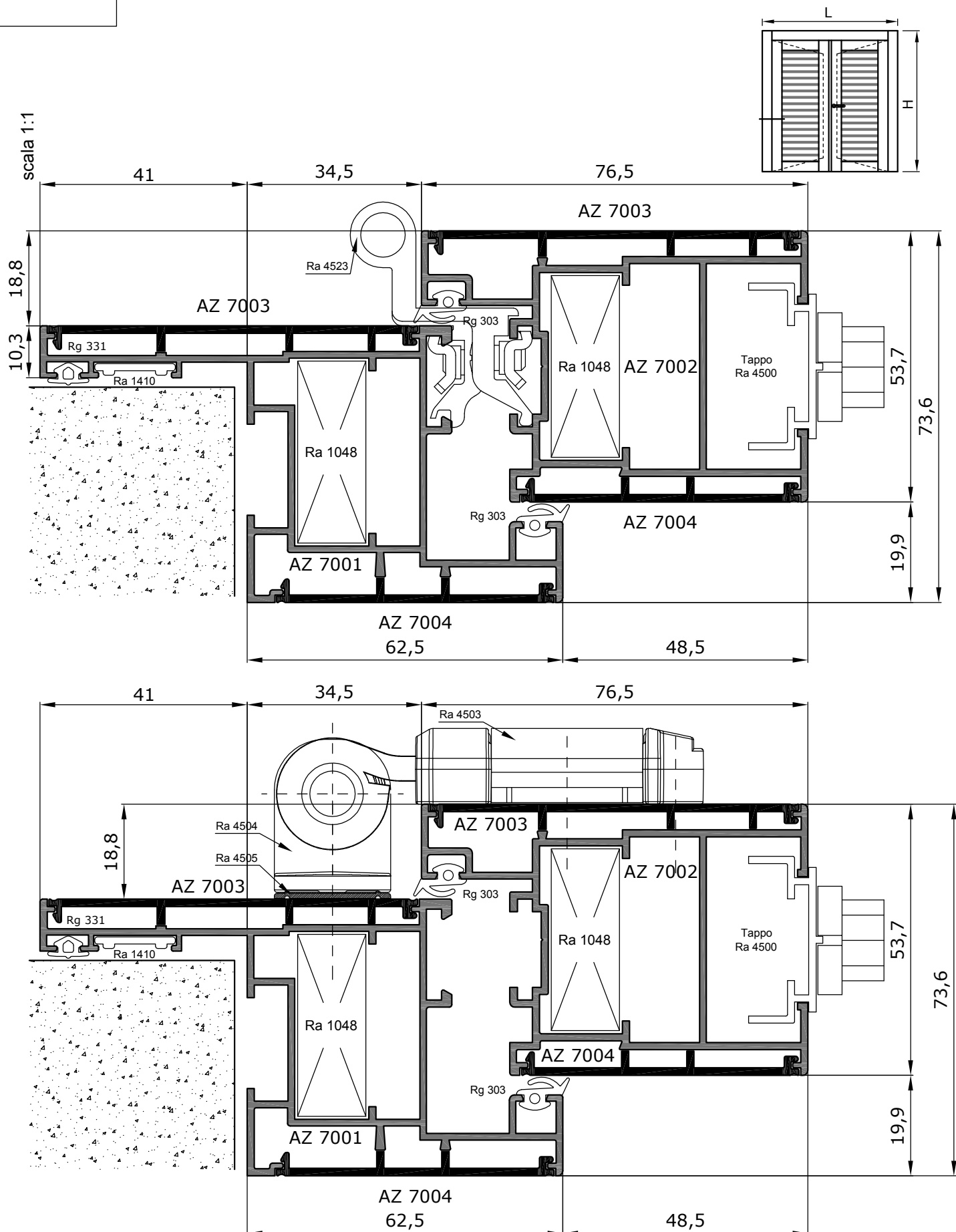

Sezione laterale Persiana 90 una anta
con martellina movimentazione bidirezionale o
spagnoletta rustico

scala 1:1

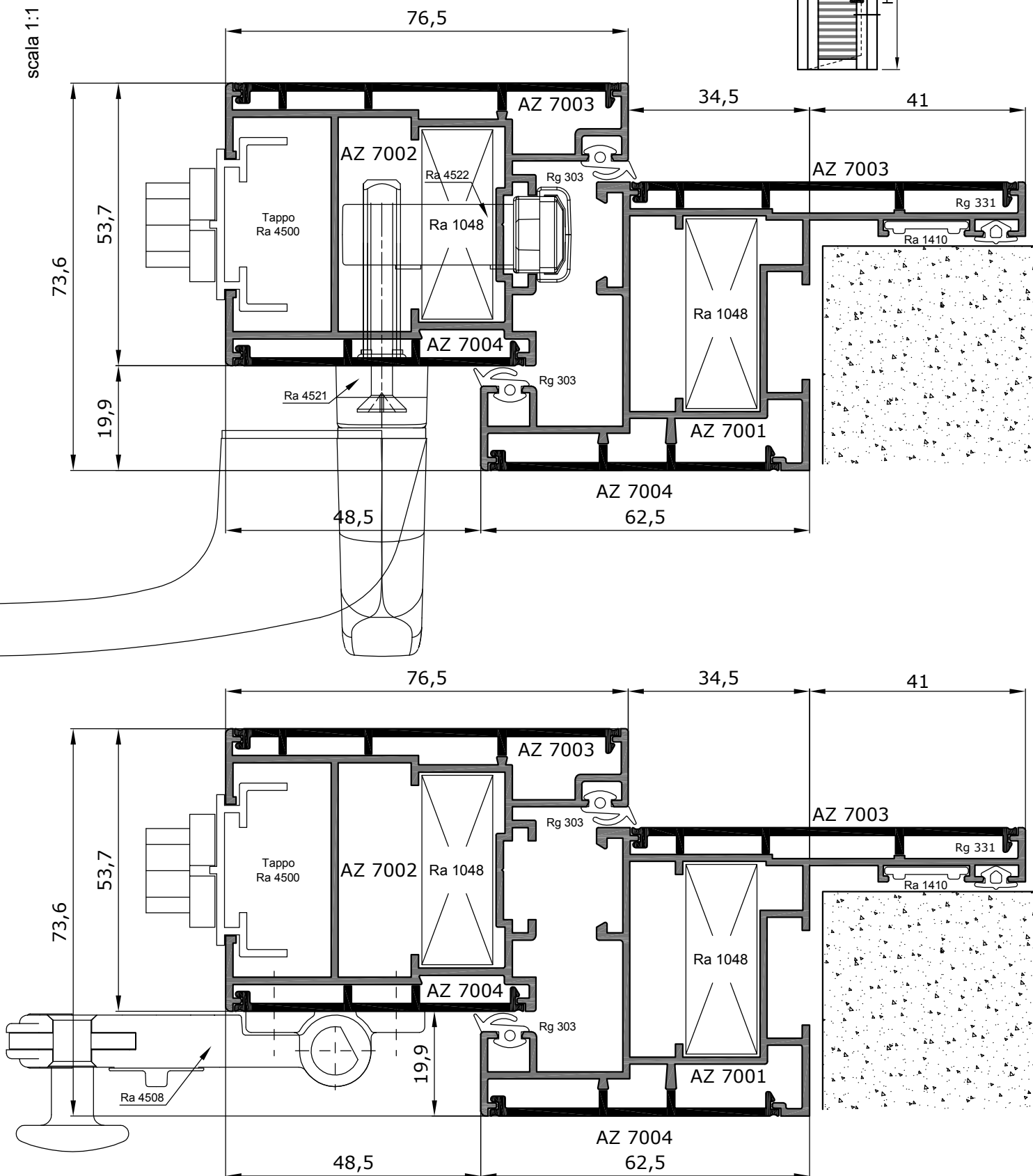
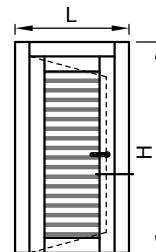

Sezione centrale Persiana 90
tre ante cerniere tipo standard
o bandella a croce rustico

scala 1:1

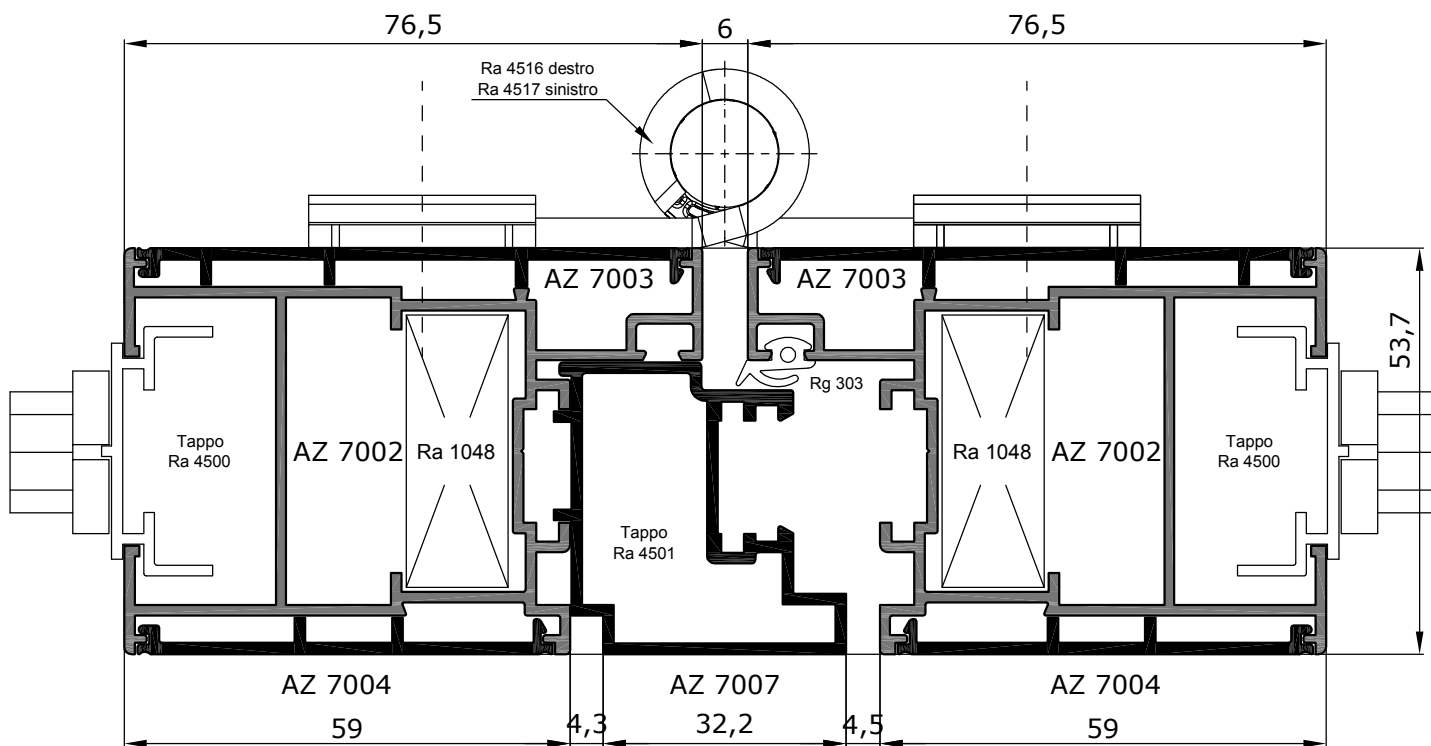
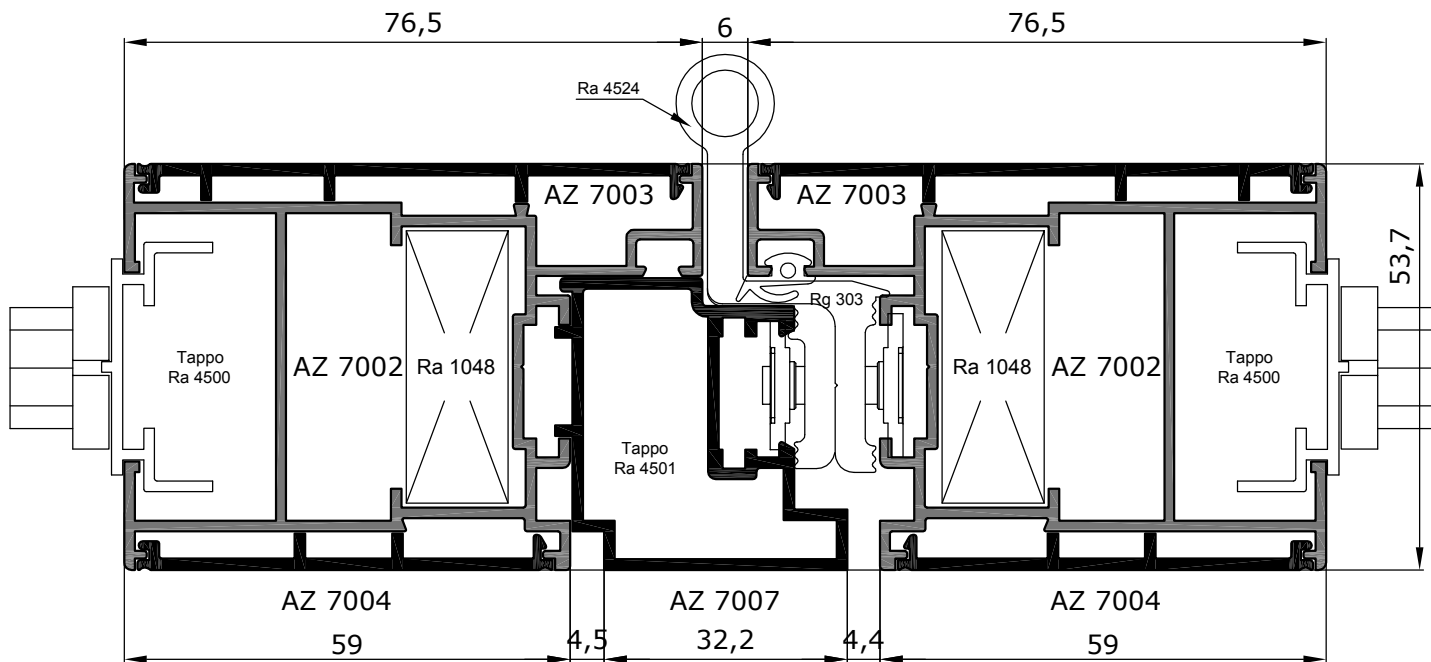
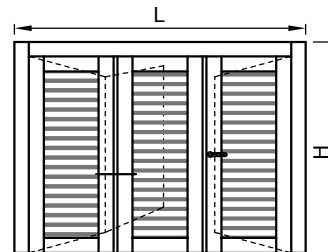

Sezione verticale Persiana 90 con zoccolo lato inferiore

scala 1:1

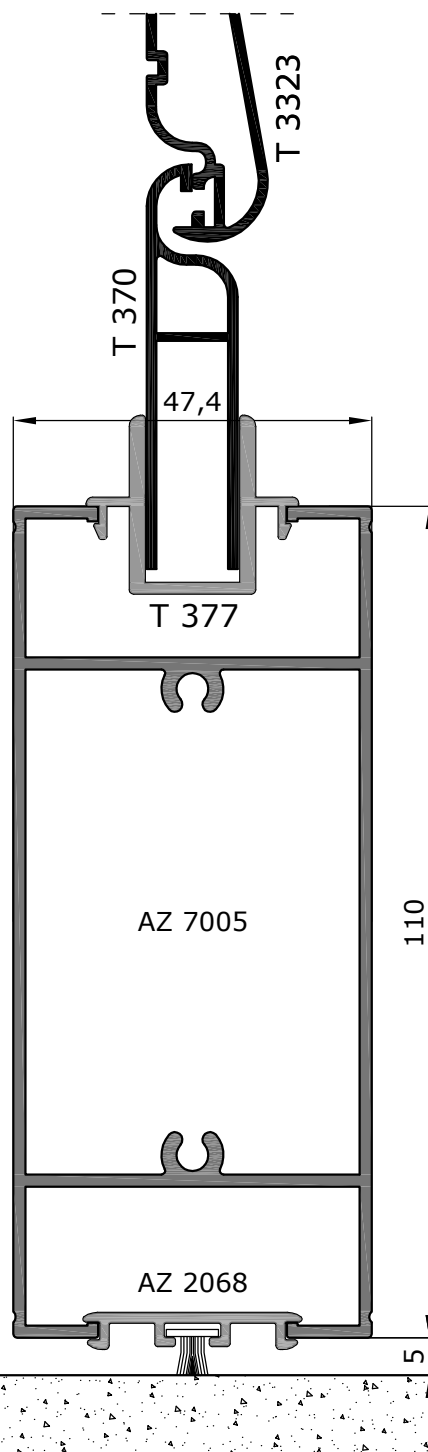
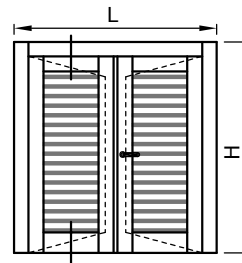
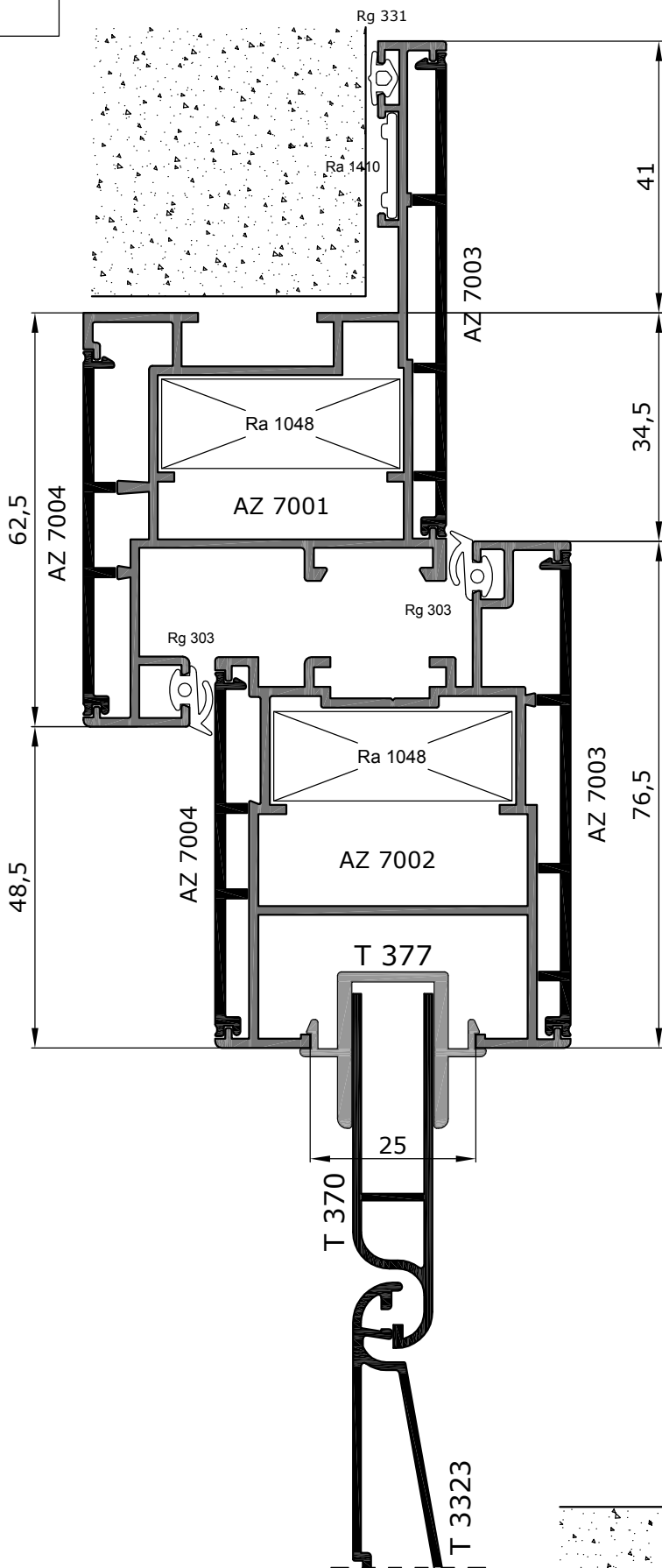

Sezione verticale Persiana 90 con anta e compensatore lato inferiore

scala 1:1

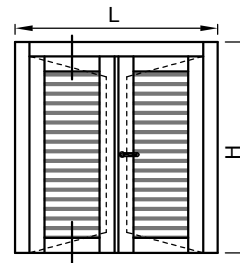
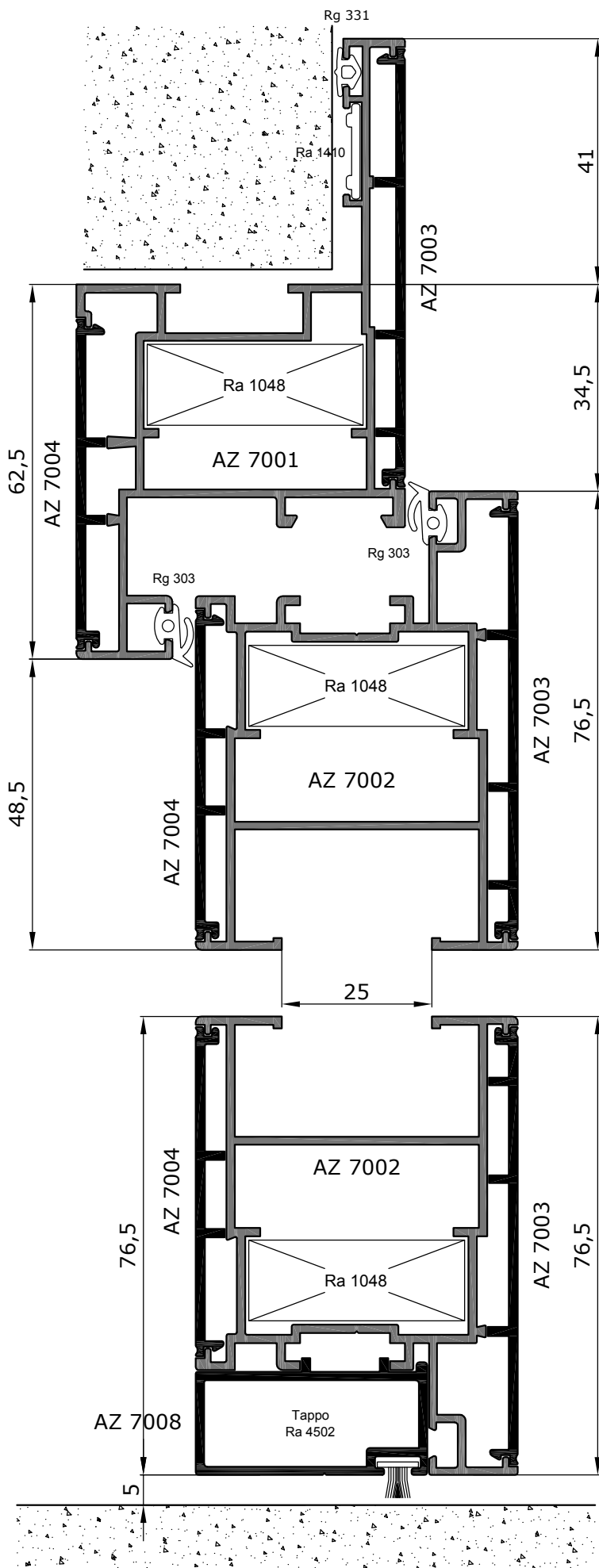

DISTINTE DI TAGLIO
Cutting sizes

Persiana Smart 90

PERSIANA AD UN'ANTA

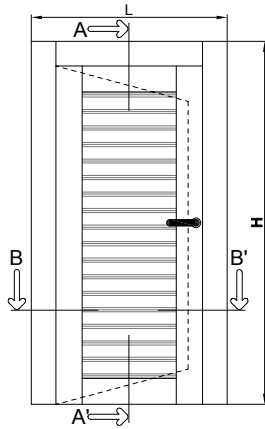

Sezione A-A'

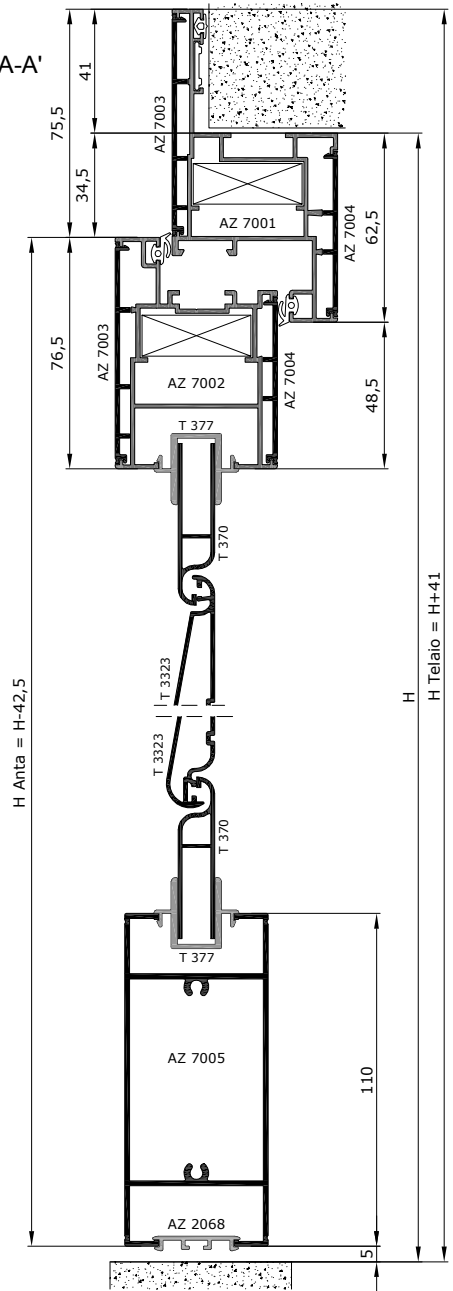

DISTINTA TAGLIO PROFILI

ARTICOLO	PROFILO	DESCRIZIONE	TAGLIO	Nr. Pezzi
AZ 7001		TELAIO Z	$H + 41$	2
			$L + 82$	1
AZ 7002		ANTA	$H - 42,5$	2
			$L - 69$	1
AZ 7003		CARTER PER ANTA	$H - 44$	2
			$L - 219$	1
AZ 7003		CARTER PER TELAI0	$H + 39,5$	2
			$L - 68$	1
AZ 7004		CARTER PER ANTA	$H - 62$	2
			$L - 219$	1
AZ 7004		CARTER PER TELAI0	$H - 5,5$	2
			$L - 122$	1
AZ 7005		ZOCCOLO	$L - 182$	1
AZ 2068		PORTA SPAZZOLINO	$L -$	1
AZ 2035		ASTINA DI COMANDO		1

GUARNIZIONI

ART.	DESCRIZIONE	N° P.zzi
Rg 303	G. BATTUTA INTERNA	2L + 4H
Rg 331	G. BATTUTA SU MURO E ANTIRUMORE	1L + 2H

ACCESSORI

ART.	DESCRIZIONE	N° P.zzi
Ra 1048	SQUADRETTA TELAI0 ANTA	4
Ra 1410	SQUADRETTA ALLINEAMENTO	2
Ra 4523	CERNIERA MONO ANTA	2
Ra 4500	TAPPI CHIUSURA ANTA	1 CP.
Ra 4521	MARTELLINA	1
Ra 4522	MOVIMENTAZIONE BIDIREZIONALE	1

L Telaio = L+82
L Anta = L-69

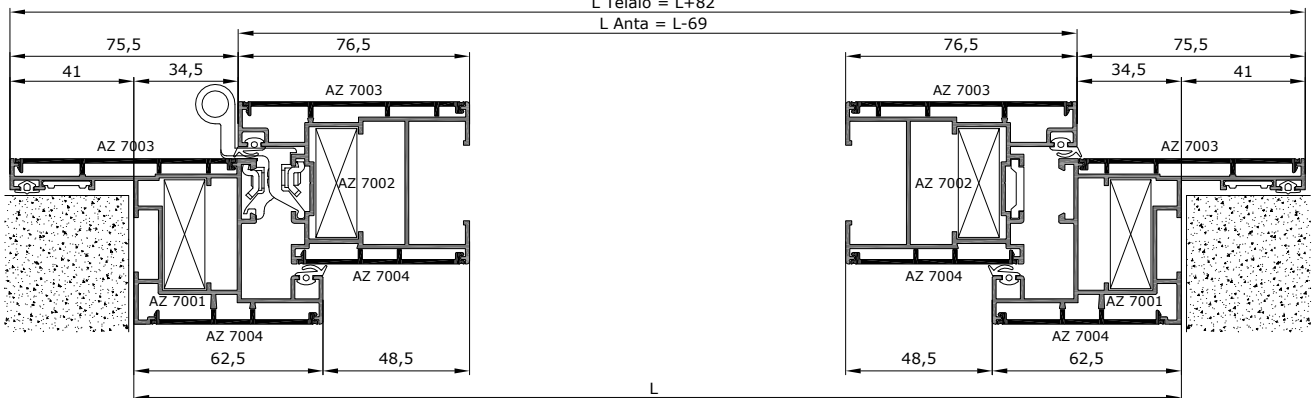

Sezione B-B'

PERSIANA DUE ANTE

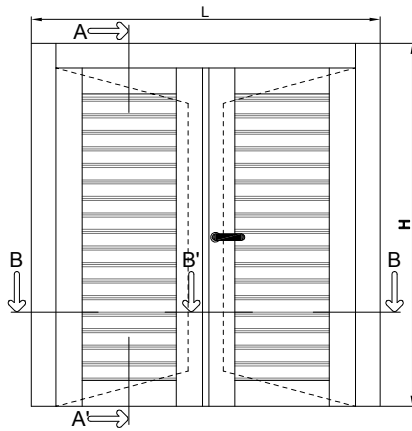

Sezione A-A'

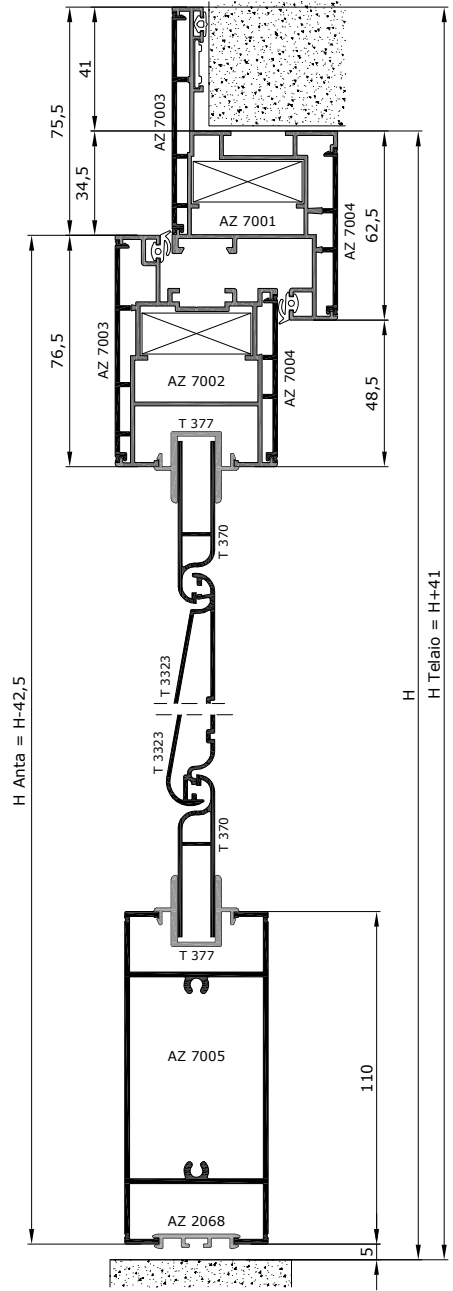

DISTINTA TAGLIO PROFILI

ARTICOLO	PROFILO	DESCRIZIONE	TAGLIO	Nr. Pezzi
AZ 7001		TELAIO Z	$H + 41$	2
			$L + 82$	1
AZ 7002		ANTA	$H - 42,5$	4
			$L/2 - 37,5$	2
AZ 7003		CARTER PER ANTA	$H - 44$	4
			$L/2 - 187,5$	2
AZ 7003		CARTER PER TELAI0	$H + 39,5$	2
			$L - 68$	1
AZ 7004		CARTER PER ANTA	$H - 62$	4
			$L/2 - 187,5$	2
AZ 7004		CARTER PER TELAI0	$H - 5,5$	2
			$L - 122$	1
AZ 7007		RIPORTO CENTRALE	$H - 61,5$	1
AZ 7005		ZOCCOLO	$L/2 - 150$	2
AZ 2068		PORTA SPAZZOLINO	$L/2 - 190$	2
AZ 2035		ASTINA DI COMANDO		1

GUARNIZIONI

ART.	DESCRIZIONE	N° P.zzi
Rg 303	G. BATTUTA INTERNA	2L + 5H
Rg 331	G. BATTUTA SU MURO E ANTIRUMORE	1L + 2H

ACCESSORI

ART.	DESCRIZIONE	N° P.zzi
Ra 1048	SQUADRETTA TELAI0 ANTA	6
Ra 1410	SQUADRETTA ALLINEAMENTO	2
Ra 4523	CERNIERA MONO ANTA	4
Ra 4500	TAPPI CHIUSURA ANTA	2 cp.
Ra 4501	TAPPI CHIUSURA RIPORTO	1 cp.
Ra 4521	MARTELLINA	1
Ra 4522	MOVIMENTAZIONE BIDIREZIONALE	1

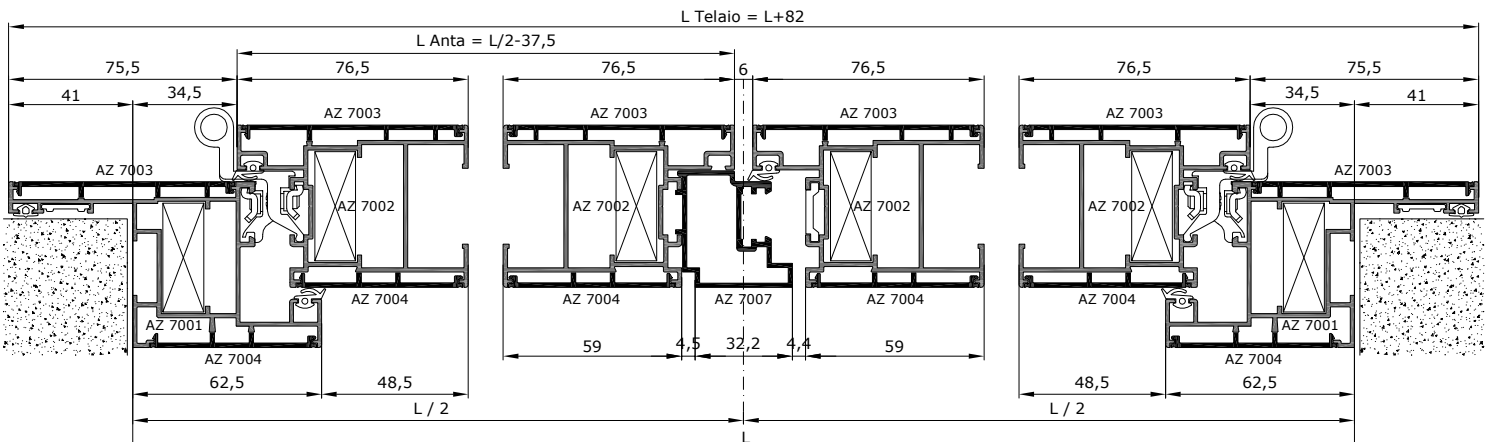

Sezione B-B'-B

distinte di taglio cutting sizes

PERSIANA TRE ANTE

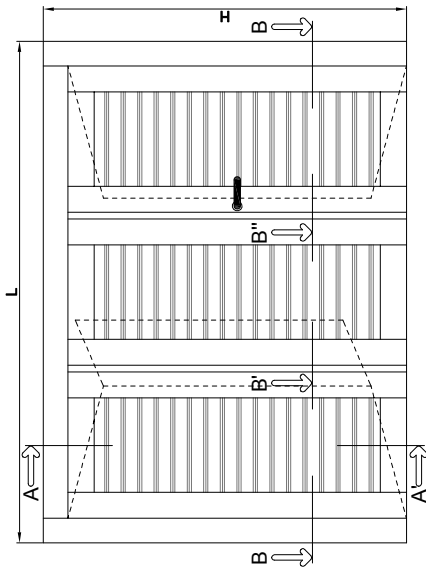

DISTINTA TAGLIO PROFILI				
ARTICOLO	PROFILO	DESCRIZIONE	TAGLIO	Nr. Pezzi
AZ 7001		TELAIO Z	H + 41 L + 82	2
AZ 7002		ANTA	H - 42,5 L/3 - 27	6
AZ 7003		CARTER PER ANTA	H - 44 L/3-177	3
AZ 7003		CARTER PER TELAI	H + 39,5 L - 68	2
AZ 7004		CARTER PER ANTA	H - 62 L/3-177	6
AZ 7004		CARTER PER TELAI	H - 5,5 L - 122	3
AZ 7007		RIPORTO CENTRALE	H - 61,5	2
AZ 7005		ZOCCOLO	L/3 - 140	3
AZ 2068		PORTA SPAZZOLINO	L/3 - 180	1
AZ 2035		ASTINA DI COMANDO		1

GUARNIZIONI			ACCESSORI		
ART.	DESCRIZIONE	N° P.zzi	ART.	DESCRIZIONE	N° P.zzi
Rg 303	G. BATTUTA INTERNA	2L + 6H	Ra 1048	SQUADRETTA TELAI ANTA	8
Rg 331	G. BATTUTA SU MURO E ANTIRUMORE	1L + 2H	Ra 1410	SQUADRETTA ALLINEAMENTO	2
			Ra 4523	CERNIERA MONO ANTA	4
			Ra 4524	CERNIERA 3° ANTA	2
			Ra 4500	TAPPI CHIUSURA ANTA	3 CP.
			Ra 4501	TAPPI CHIUSURA RIPORTO	1 CP.
			Ra 4521	MARTELLINA	1
			Ra 4522	MOVIMENTAZIONE BIDIREZIONALE	1

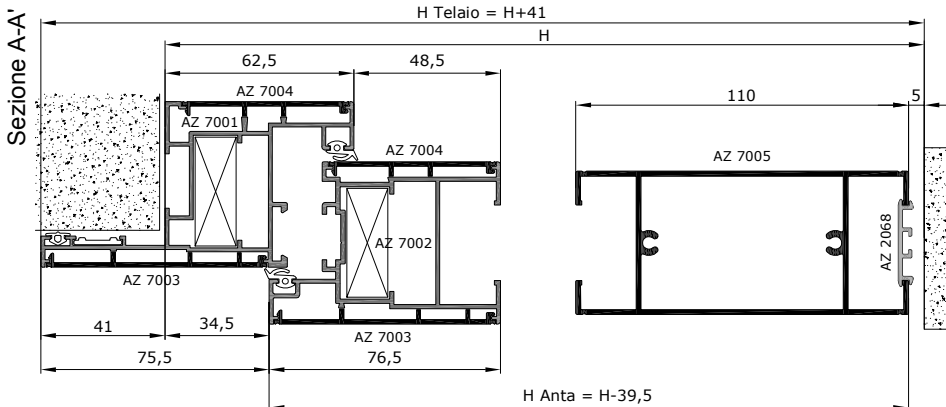

Sezione B-B'-B''-B

